



YU-I PASS UVSS

Under Vehicle Surveillance System

Professional provider of checkpoint security solution



YU-I PASS

TSOLUTIONS CO.,LTD. was established in 2004, Company start distributed Telecommunication from ARTECH Technology (Taiwan) for VoIP Gateway (Voice Over IP), Mobile Gateway to serve the market demand for telephone cost saving solution, Voice Logger to keep the record of all conversation on telephone to improve level of services of Securities, BANK and other Financial industry.

We have added security product into company product line, we have cooperation with VIVOTEK INC. (Taiwan) since 2009 Which provide a crystal clear image quality CCTV system, we also added IPPBX product from TRANSTEL Communication (USA) to fulfill the market need from Hospitality industry.

We have added Software Development Team to customization the wide range of Image Processing Software such as LPR, Face Recognition and many application. We have 15th years of experience for Integrated Security and Telecommunication to choose the suitable product and deliver the best TCO solution for our customer.

Introduction

The whole solution includes under vehicle scanning system (UVSS), under vehicle video surveillance system, number plate recognition (NPR), driver face recognition, IP CCTV, etc.

The system is ideal for government, military, custom, hotel and transportation corporation facility requiring security check points for vehicles such as vans, tractor trailers, buses and passenger vehicles, even for trains.

The core system in the solution, UVSS adopts the world's leading intelligent area scanning camera, to effectively scan and inspect in real time the under carriage of vehicles to search and analyze images for explosive devices, suspicious objects or contraband such as drugs and weapons.



4K Area scan

Comparing with the outdated ordinary line scan camera in the traditional system, YU-I Pass UVSS adopts the latest intelligent area scan camera technology.

Support vehicle changing speed while scanning

Built in ISP SPEED DETECTOR (ISD), there for no strict requirement for the speed of the vehicle. The image quality will not be affected no matter vehicle changing speed, or even stop and move.

Vehicle speed up to 60 km/h

Based on ultra high frame rate sensor, together with specially designed ASIC like processor, YU-I Pass area scan technology makes it possible for UVSS to capture high speed vehicle up to 60 km/h.

4096p image resolution

High resolution color image allows zoom in to all details in concern

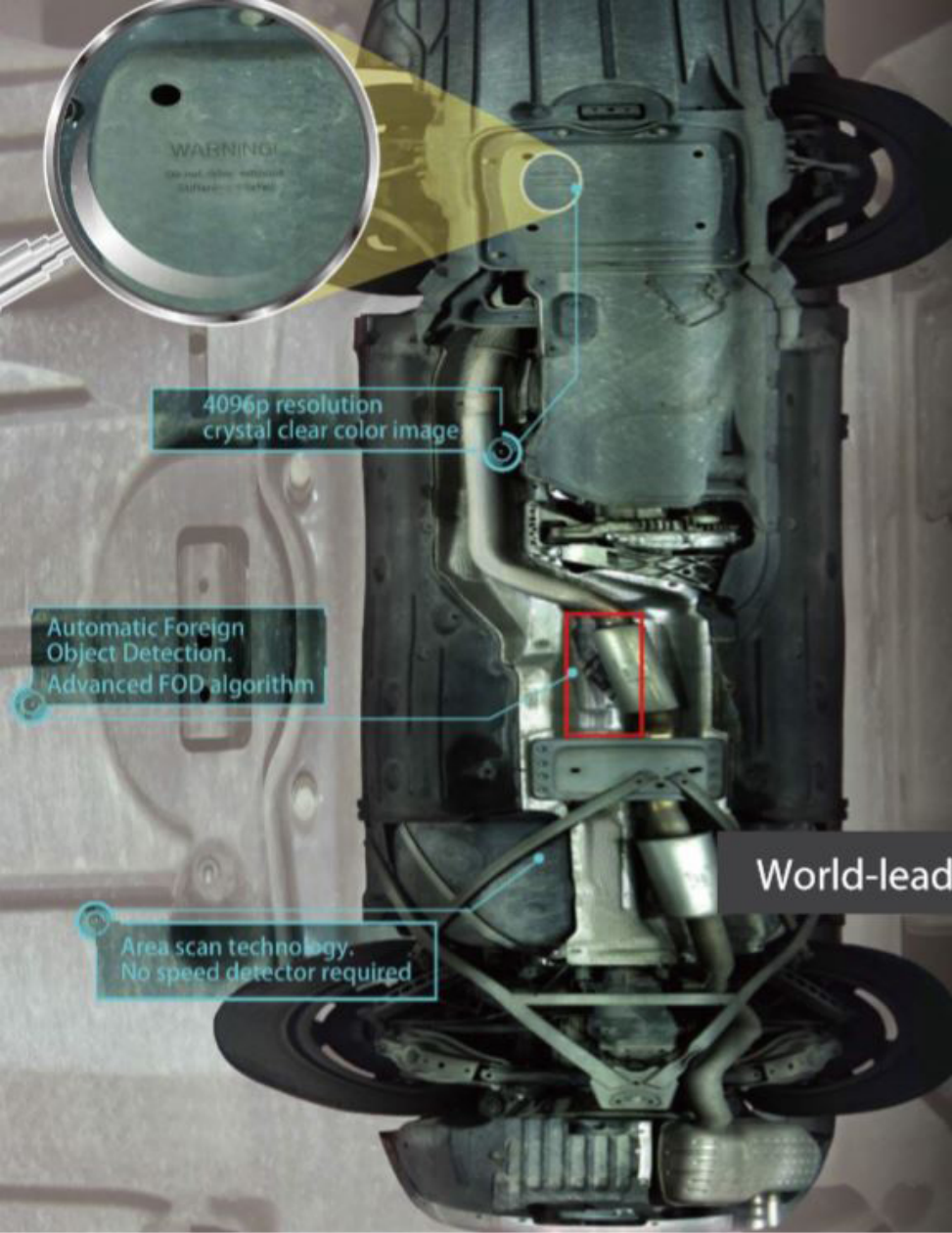

World-leading proprietary technology



Linear Scan

VS



Area Scan

Modular design

ALL-IN-ONE camera
easy to make **YOUR OWN** UVSS

- Fixed usage
- Color Area Scan technology
- Capture even at speeds up to 60KMPH
- High resolution imaging up to full 4096p
- No limits on the length of a scan
- Modular design
- Ultra thin design, convenient construction
- Low power consumption, less than 80W while working
- All-in-one ground camera solution, no need expensive server
- Adopt the advanced intelligent camera, encoding all completed images by camera itself
- All weather conditions for the harshest environment

70°C
-40°C IP68 FC CE

All-in-one camera technology

Finish image processing and generate whole under carriage image in camera itself, no need the help of computer. Analysis speed of vehicle by camera itself, no need additional vehicle speed measurement equipment. With simple http standard API interface, UVSS can be easily integrated into your own system. Auto exposure image sensor, automatically adjust brightness, without operator intervention, make the system works well for different height undercarriages, such as vans, tractor trailers, buses and passenger vehicles.



Sedan



Truck



Train

All in one camera

Low construction and maintenance cost

Supper slim design, as slim as 6 cm, save lot of construction time and cost. Modular design, fast maintenance in less than 10 minutes.



+

custom
made
cover

=

your
own
UVSS



World-leading AI technologies

Advanced AI technology algorithm specially developed for undercarriage analysis.

Undercarriage big data, identifies the vehicle's model

Deep Neural Networks (DNN) technology proved the capability to identify the vehicle's model. The self-learning database provides big-data for car analytics.

Proprietary FOD (Foreign Object Detection) algorithm

The system is capable of automatically identifying and highlighting any change or difference between a newly scanned vehicle's undercarriage and the undercarriage of the reference image of the same or similar vehicle without the intervention of a system operator.

Proprietary FOD algorithm



Newly scanned



Reference image

PRODUCTS

- Professional Fixed UVSS
- Professional Mobile UVSS
- Lite Fixed UVSS
- Lite Mobile UVSS
- Video UVSS
- Hand held UVSS
- Face Recognition Camera
- Number Plate Recognition Camera
- Management Software

Professional Fixed UVSS

MODEL NO: UVS310-PFC

Professional Fixed UVSS adopts the most advanced area scanning technology, it is designed for places where have high security requirements, like government, military, custom, etc.



Features:

- Fixed usage
- Color Area Scan technology
- Capture even at speeds up to 60km/h
- High resolution imaging up to full 4096p
- No limits on the length of a scan
- All-in-one ground camera solution, no need expensive server
- All weather conditions for the harshest environments
- Adopt the advanced intelligent camera, encoding all completed images by camera itself

Specifications:

Performance	
Capture Accuracy	> 99.9%
Speed Limit	0 ~ 60km/h
Intelligent Analysis	Auto
Height of Vehicle Chassis	50 ~ 3000mm
Width of Vehicle Chassis	≤ 4500mm
Length of Vehicle Chassis	No limit
Imageing Time	< 1s
System Extension	NPR & Face Recognition
Foreign Object Detection	Optional
Load Bearing Capacity	60 Tonnes

Camera	
Sensor Resolution	4096P
Image Resolution	≥ 10000 x 4096
View Angle of Lens	> 170°
White Balance	Auto
Exposure	Auto

Network	
Speed	Gigabit Ethernet
Protocol	IPv4

Electrical	
Power Supply	DC24V/150W
Constructions	
Dimensions	1236mm x 320mm x 105mm
Weight	45kg
Environment	
Operating Temperature	-40℃~+70℃
Protection level	IP68

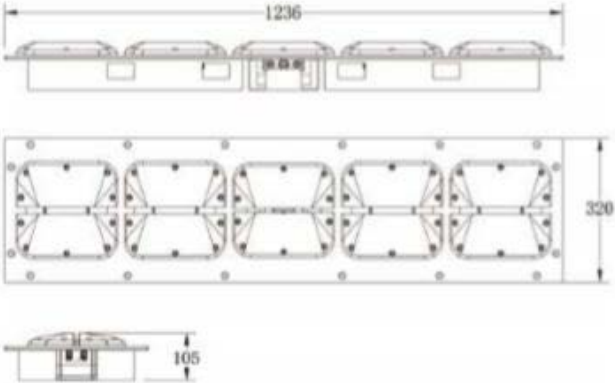

Professional Mobile UVSS

MODEL NO: UVS310-PMC

Professional Mobile UVSS adopts the most advanced area scanning technology, it is designed for places where have high security requirements, like government, military, custom, etc.

Features:

- Surface mount
- Color Area Scan technology
- Capture even at speeds up to 60km/h
- High resolution imaging up to full 4096p
- No limits on the length of a scan
- All-in-one ground camera solution, no need expensive server
- All weather conditions for the harshest environments
- Adopt the advanced intelligent camera, encoding all completed images by camera itself



Specifications:

Performance	
Capture Accuracy	> 99.9%
Speed Limit	0 ~ 60km/h
Intelligent Analysis	Auto
Height of Vehicle Chassis	80 ~ 3000mm
Width of Vehicle Chassis	≤ 4500mm
Length of Vehicle Chassis	No limit
Imageing Time	< 1s
System Extension	NPR & Face Recognition
Foreign Object Detection	Optional
Load Bearing Capacity	40 Tonnes

Camera	
Sensor Resolution	4096P
Image Resolution	≥ 10000 x 4096
View Angle of Lens	> 170°
White Balance	Auto
Exposure	Auto

Network	
Speed	Gigabit Ethernet
Protocol	IPv4

Electrical	
Power Supply	DC24V/150W

Constructions	
Dimensions	1100mm x 296mm x 65mm
Weight	35kg

Environment	
Operating Temperature	-40 C ~+70 C
Protection level	IP68

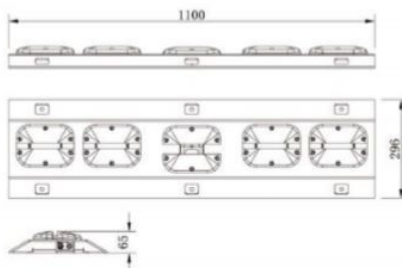

Lite Fixed UVSS

MODEL NO: UVS310-LFC

Lite fixed UVSS is an entry level under vehicle scanning solution. It adopts also intelligent area scan technology, while it is a cost effective choice for users.

Features:

- Fixed usage
- Color Area Scan technology
- Capture even at speeds up to 30km/h
- High resolution imaging up to full 1024p
- No limits on the length of a scan
- All-in-one ground camera solution, no need expensive server
- All weather conditions for the harshest environments
- Adopt the advanced intelligent camera, encoding all completed images by camera itself



Specifications:

Performance	
Capture Accuracy	> 99.9%
Speed Limit	0 ~ 30km/h
Intelligent Analysis	Auto
Height of Vehicle Chassis	50 ~ 3000mm
Width of Vehicle Chassis	≤ 4500mm
Length of Vehicle Chassis	No limit
Imageing Time	< 1s
System Extension	NPR & Face Recognition
Foreign Object Detection	Not support
Load Bearing Capacity	60 Tonnes

Camera	
Sensor Resolution	1024P
Image Resolution	≥ 2000 x 1024
View Angle of Lens	> 170°
White Balance	Auto
Exposure	Auto

Network	
Speed	Gigabit Ethernet
Protocol	IPv4

Electrical	
Power Supply	DC24V/150W

Constructions	
Dimensions	1236mm x 320mm x 105mm
Weight	45kg

Environment	
Operating Temperature	-40 C ~+70 C
Protection level	IP68

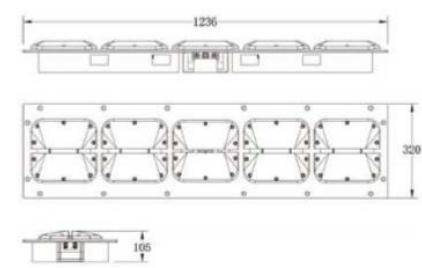

Lite Mobile UVSS

MODEL NO: UVS310-LMC

Lite Mobile UVSS is an entry level under vehicle scanning solution. It adopts also intelligent area scan technology, while it is a cost effective choice for users.

Features:

- Surface mount
- Color Area Scan technology
- Capture even at speeds up to 30km/h
- High resolution imaging up to full 1024p
- No limits on the length of a scan
- All-in-one ground camera solution, no need expensive server
- All weather conditions for the harshest environments
- Adopt the advanced intelligent camera, encoding all completed images by camera itself



Specifications:

Performance	
Capture Accuracy	> 99.9%
Speed Limit	0 ~ 30km/h
Intelligent Analysis	Auto
Height of Vehicle Chassis	80 ~ 3000mm
Width of Vehicle Chassis	≤ 4500mm
Length of Vehicle Chassis	No limit
Imaging Time	< 1s
System Extension	NPR & Face Recognition
Foreign Object Detection	Not support
Load Bearing Capacity	40 Tonnes

Camera	
Sensor Resolution	1024P
Image Resolution	≥ 2000 x 1024
View Angle of Lens	> 170°
White Balance	Auto
Exposure	Auto

Network	
Speed	Gigabit Ethernet
Protocol	IPv4

Electrical	
Power Supply	DC24V/150W

Constructions	
Dimensions	1100mm x 296mm x 65mm
Weight	35kg

Environment	
Operating Temperature	-40°C ~ +70°C
Protection level	IP68

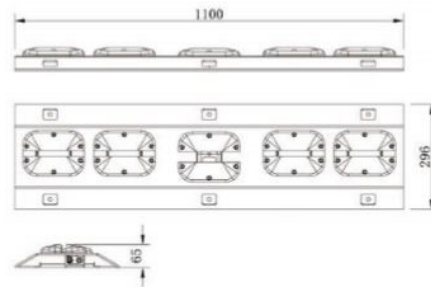

Professional Fixed UVSS

MODEL NO: UVS300-PFC

Professional Fixed UVSS adopts the most advanced area scanning technology, it is designed for places where have high security requirements, like government, military, custom, etc.

Features:

- Surface usage
- Color Area Scan technology
- Capture even at speeds up to 60km/h
- High resolution imaging up to full 4096p
- No limits on the length of a scan
- All-in-one ground camera solution, no need expensive server
- All weather conditions for the harshest environments
- Adopt the advanced intelligent camera, encoding all completed images by camera itself



Specifications:

Performance	
Capture Accuracy	> 99.9%
Speed Limit	0 ~ 60km/h
Intelligent Analysis	Auto
Height of Vehicle Chassis	80 ~ 3000mm
Width of Vehicle Chassis	≤ 4500mm
Length of Vehicle Chassis	No limit
Imaging Time	< 1s
System Extension	NPR & Face Recognition
Foreign Object Detection	Optional
Load Bearing Capacity	60 Tonnes

Camera	
Sensor Resolution	4096P
Image Resolution	≥ 10000 x 4096
View Angle of Lens	> 170°
White Balance	Auto
Exposure	Auto

Network	
Speed	Gigabit Ethernet
Protocol	IPv4

Electrical	
Power Supply	DC24V/150W

Constructions	
Dimensions	1236mm x 320mm x 93mm
Weight	26kg

Environment	
Operating Temperature	-40°C ~ +70°C
Protection level	IP68

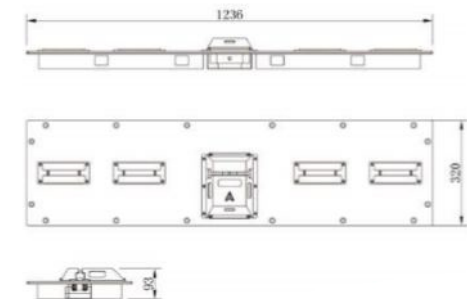

Professional Mobile UVSS

MODEL NO: UVS300-PMC

Professional Mobile UVSS adopt the most advanced area scanning technology, it is designed for places where have high security requirements, like government, military, custom, etc.

Features:

- Surface mount
- Color Area Scan technology
- Capture even at speeds up to 60km/h
- High resolution imaging up to full 4096p
- No limits on the length of a scan
- All-in-one ground camera solution, no need expensive server
- All weather conditions for the harshest environments
- Adopt the advanced intelligent camera, encoding all completed images by camera itself



Specifications:

Performance	
Capture Accuracy	> 99.9%
Speed Limit	0 ~ 60km/h
Intelligent Analysis	Auto
Height of Vehicle Chassis	80 ~ 3000mm
Width of Vehicle Chassis	≤ 4500mm
Length of Vehicle Chassis	No limit
Imageing Time	< 1s
System Extension	NPR & Face Recognition
Foreign Object Detection	Optional
Load Bearing Capacity	20 Tonnes

Camera	
Sensor Resolution	4096P
Image Resolution	≥ 2000 x 1024
View Angle of Lens	> 170°
White Balance	Auto
Exposure	Auto

Network	
Speed	Gigabit Ethernet
Protocol	IPv4

Electrical	
Power Supply	DC24V/150W

Constructions	
Dimensions	760mm x 355mm x 85mm
Weight	20kg

Environment	
Operating Temperature	-40 °C ~ +70 °C
Protection level	IP68

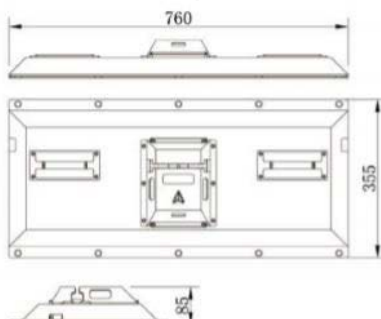

Video UVSS

MODEL NO: UVS100-VMB

Video UVSS is a video monitoring system for low cost and entry level under vehicle surveillance requirements. It can be used alone with NVR, or be used together with under vehicle image scanning system.

Features:

- Surface mount
- Real time video output
- Gray scale image
- High resolution imaging up to full 1080p
- Support standard Onvif protocol
- Infrared LED illuminance
- All weather conditions for the harshest environments
- Adopt High Dynamic Range technology

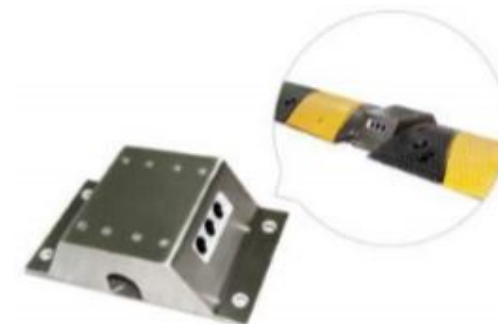

Specifications:

Performance	
Capture Accuracy	> 99.9%
Speed Limit	0 ~ 5km/h
Intelligent Analysis	No
Height of Vehicle Chassis	80 ~ 800mm
Width of Vehicle Chassis	≤ 2000mm
Length of Vehicle Chassis	No limit
System Requirements	NVR / Server

Camera	
Sensor Resolution	1080P
View Angle of Lens	> 90°
Exposure	Auto
Infrared illumination	850 nm

Electrical	
Power Supply	DC24V/50W

Network	
Speed	Gigabit Ethernet
Protocol	IPv4

Constructions	
Dimensions	230mm x 136mm x 63mm
Weight	3kg

Environment	
Operating Temperature	-10 °C ~ +70 °C
Protection level	IP68

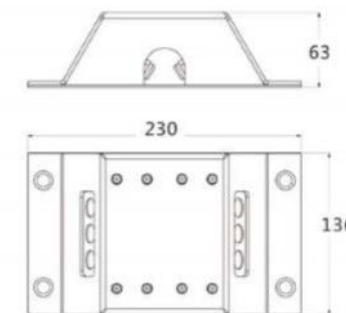

Hand Held UVSS

MODEL NO: UVHDC100

Hand Held UVSS is an ideal solution for checkpoints or any area where under vehicle security inspection are required.

Features:

- Detachable
- Includes two HD camera
- Supply all-round inspection for the vehicles, even small cavities, pipes, etc
- High resolution imaging up to full 1080p
- Supports up to 64GB TF card
- Built-in 5000mAh high capacity Li-battery
- 7-inch HD screen with sun visor



Specifications:

Performance	
Number of Cameras	2
Telescopic Pole	2m
Number of LED	16
Video compression Format	H.264
Photo Format	JPG
Metal monitor bracket	Adjustable
Working Time	8 hours
System Upgrade	Auto

Camera	
Sensor Resolution	1080P
Sensor Size	≥ 5.6mm x 3.14mm
View Angle of Lens	> 120°
White Balance	Auto
Exposure	Auto

Electrical	
Power Supply	DC5-24V

Monitor	
Resolution	1920 x 1080
Size	7 inch

Constructions	
Packing Dimensions	660mm x 350mm x 170mm
Weight of packing	8.0kg
Environment	
Operating Temperature	0℃~+60℃
Protection level	IP68

Face Recognition Camera

MODEL NO: FRC2231T

Featuring a True Day/Night, 2-megapixel resolution HD camera in parking and access control environment, capture the driver's face clearly in low light condition.

Features:

- Smart Codec (H.265+ & H.264+)
- High performance CCD image sensor, high color reduction degree, high sensitivity
- Built-in polarization filter switching module, fortalking clear image of driver face
- Temperature -30℃~+80℃, Humidity 10%~90%, suitable for the rough work scene. Wide working temperature, IP67 and superior performance for outdoor



Specifications:

Performance	
Capture Accuracy	> 99.9%
Speed Limit	0 ~ 60km/h
Intelligent Analysis	Auto
Focal Length	4.7 ~ 47mm
Focal control	Manual
Focal Distance Range	10-40m
IR Distance	40m
Scanning System	Progressive

Camera	
Sensor Resolution	1080P
Image Resolution	≥ 1920 x 1080P
View Angle of Lens	H:100°~37°; V:55°~21°
White Balance	Auto/Manual
Exposure	Auto

Electrical	
Power Supply	AC220V/Max40W

Network	
Speed	Gigabit Ethernet
Protocol	IPv4/IPv6

Constructions	
Dimensions	244.1mm×79mm×75.9mm
Weight	1kg
Environment	
Operating Temperature	-30℃~+80℃
Protection level	IP67

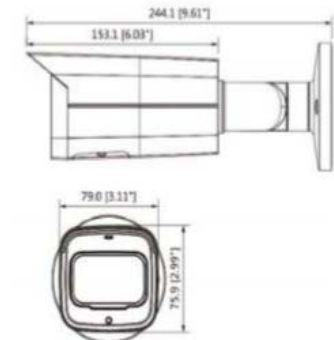

Number Plate Recognition Camera

MODEL NO: NPC237

Featuring a True Day/Night, 2-megapixel resolution LPR camera in parking and access control environment, video detect and recognize the plate in low speed less than 40km/h with embedded LPR algorithm.

Features:

- Embedded with NPR algorithm inside the camera (not for all countries)
- Support plate cutout, overview picture snapshot and video recording
- Embedded with whitelist and blacklist database
- Powerful 4.7-47 mm motorized lens and IR light, ideal for long distance ANPR as for as 40m
- Wide working temperature, IP67 and superior performance for outdoor applications



Specifications:

Camera	
Compression	H.265/H.264M/H.264H/H.264B
Resolution	1080P(1920x1080)
Frame Rate	1080P(1 ~ 25/30fps)
Bit Rate Control	CBR VBR
Bit Rate	H.264: 80K bps~ 10Mbps
Day/Night	Auto(ICR) / Color / B/W
BLC Mode	BLC,HLC,WDR(140db)
White Balance	Auto/Manual
Gain Control	Auto/Manual
Noise Reduction	3D
Smart IR	Support
Audio Interface	Input/Output 1 Input / 1 Output
RS485	N/A
Alarm	2/1 channel In/Out

Network	
Ethernet	RJ-45 (10/100Base-T)
Protocol	IPv4/IPv6, HTTP, TCP/IP, UDP, NTP, DHCP, DNS
Interoperability	CGI, Onvif
Max. User Access	20
Edge Storage	Micro SD, Max 128GB Status Display Local PC for Instant Recording
Web Viewer	IE8,IE9,IE10,IE11

Electrical	
Power Supply	POE+ (802.3at)
Power Consumption	17W

Environmental	
Operating Conditions	-30°C~+60°C, Less than 95% RH
Ingress Protection & Vandal Resistance	IP66

Construction	
Dimensions	425 x 160 x 146(mm)
Net Weight	4.2kg

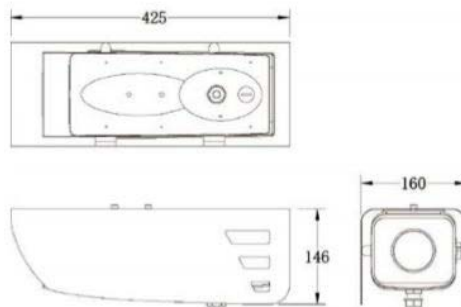

Management Software

MODEL NO: UVSecure-206

UVSecure Management Software is a powerful and easy to use software for both basic and advanced needs.

Except regular user and device management, it has a lot of optional advanced intelligent features, such as Undercarriage Recognition, Vehicle Type Recognition, Foreign Object Detection (FOD), Face Recognition, Number Plate Recognition(NPR), and etc.

Features:

- AI technology
- FOD based on plate number
- FOD based on database
- Fast FOD algorithm($\leq 3s$)
- Plate number blacklist & whitelist
- Face recognition
- Face blacklist & whitelist
- Full control to blacklist & whitelist
- Watch livemedia
- Multiple devices
- No limit to logined users
- User group management



Specifications:

Performance	
Image Upload Time	< 1s
Vehicle Type Recognition	Auto
FOD Time	$\leq 3s$
Face Recognition Time	$\leq 3s$
Warning Type	Sound/popup
Space Control	Auto
User Control	Manual
Language	customizable
Black/white list Operation	Add/edit/delete
Number of Black/white list	2000
Number of Images Group	Based on harddisk space
FR Sensitivity Range	0-100
FOD Sensitivity Range	0-8
Display	Auto fit

Recommended Server Configurations	
Operation System	Windows 7+
Architecture	AMD64
Memory	8GB
Hard Disk	$\geq 100G$
Processor	\geq Intel I3
Screen Resolution	$\geq 1280 \times 720$



THANK YOU

TSOLUTIONS COMPANY LIMITED

16/87-88 Soi Ladplakao 12, Chorakhe Bua,
Ladprao, Bangkok, 10230

www.tsolutions.co.th

www.mytsolutions.com

Call : +66 2 5700444

Fax : +66 2 5700442

Technical Hotline : +66 83 999 2488

Email : sales@tsolutions.co.th